

Title ***RH84 Tube Amplifier***

Size: A4 Number: 1 Revision: 1.0.0.0

Date: 4/2/2020 Time: 5:03:21 PM Sheet 1 of 1

logo
DANO



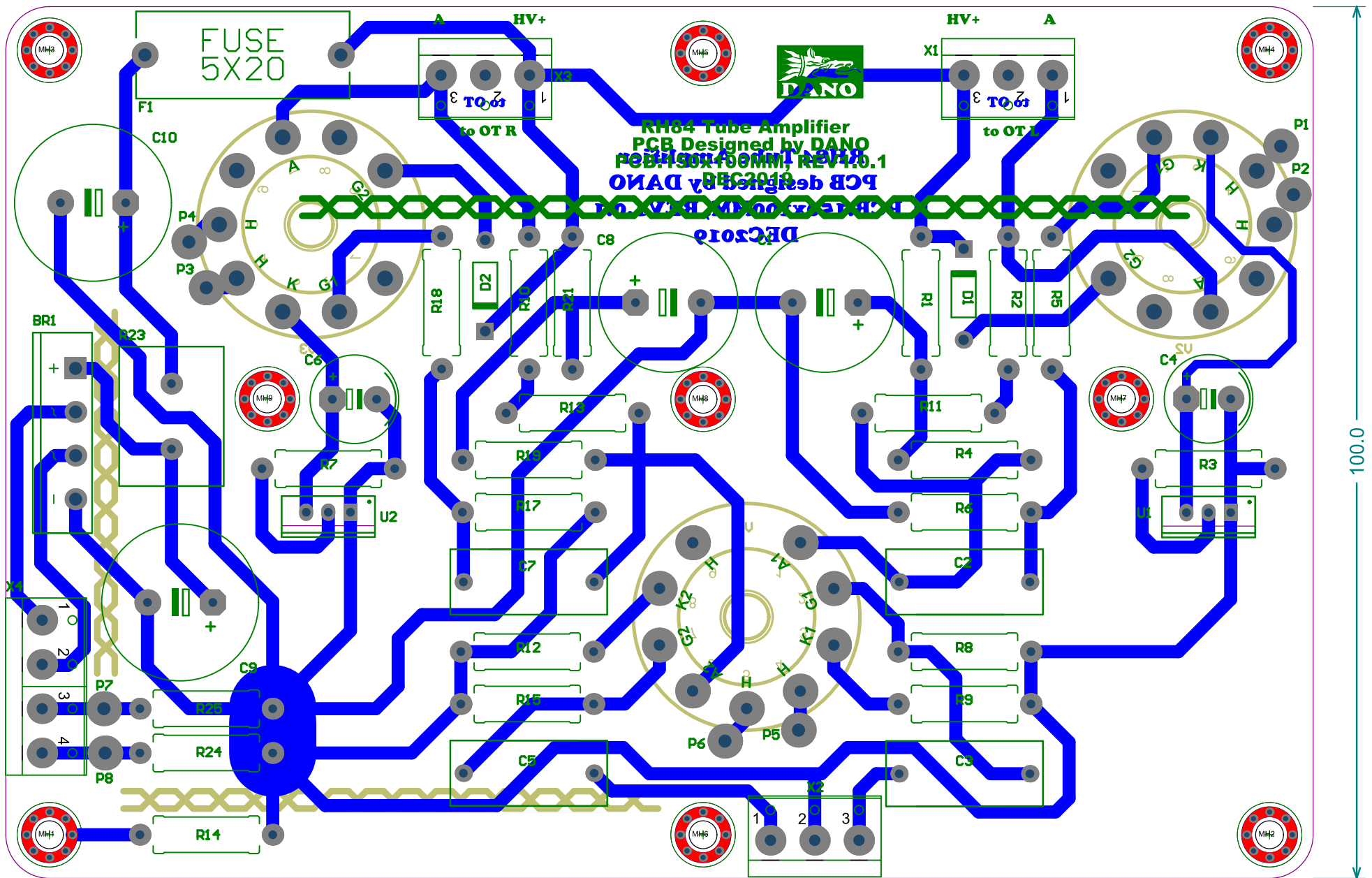

RH84 Tube Amplifier
PCB Designed by DANO
PCB: 150x100MM, REV 1.0.1
DANO

DEC2019

FUSE
5X20

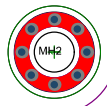
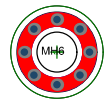
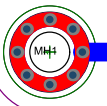
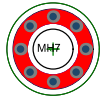
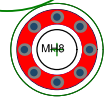
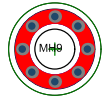
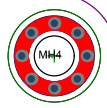
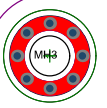

100.0

150.0

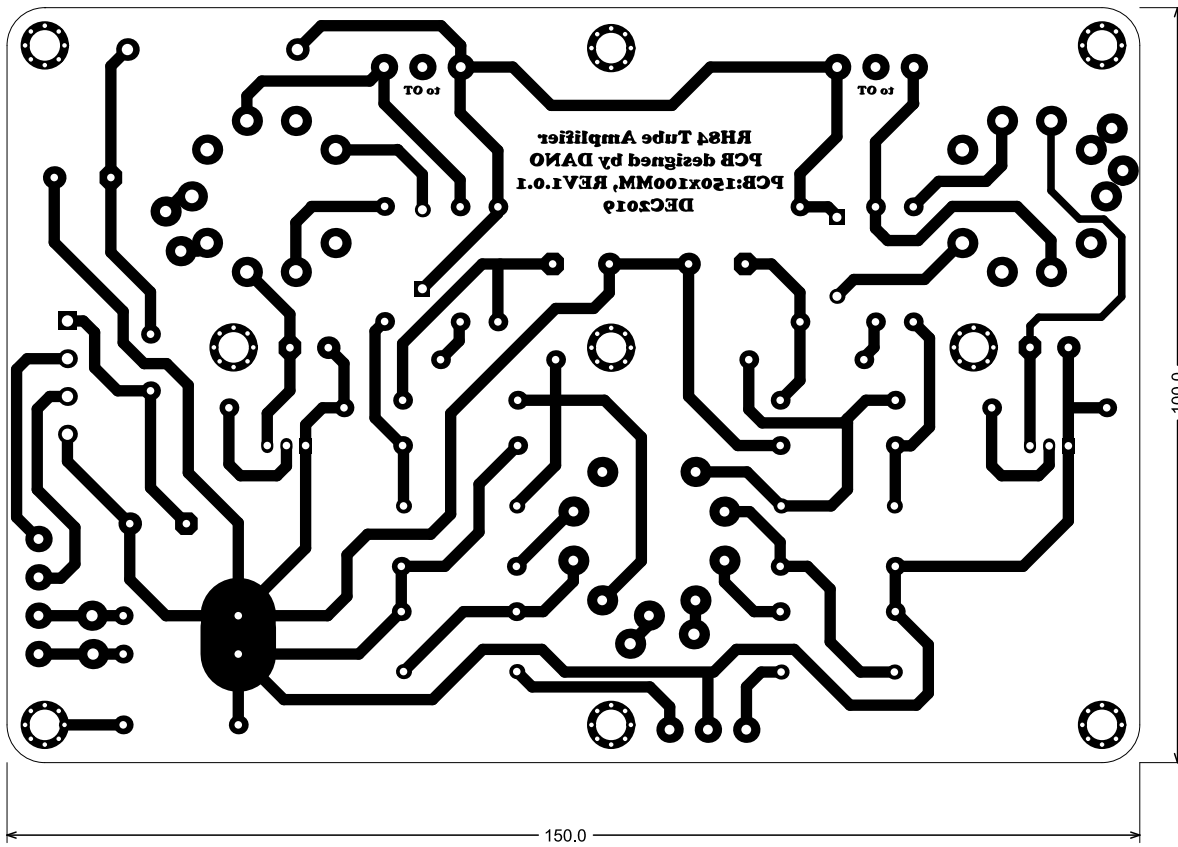

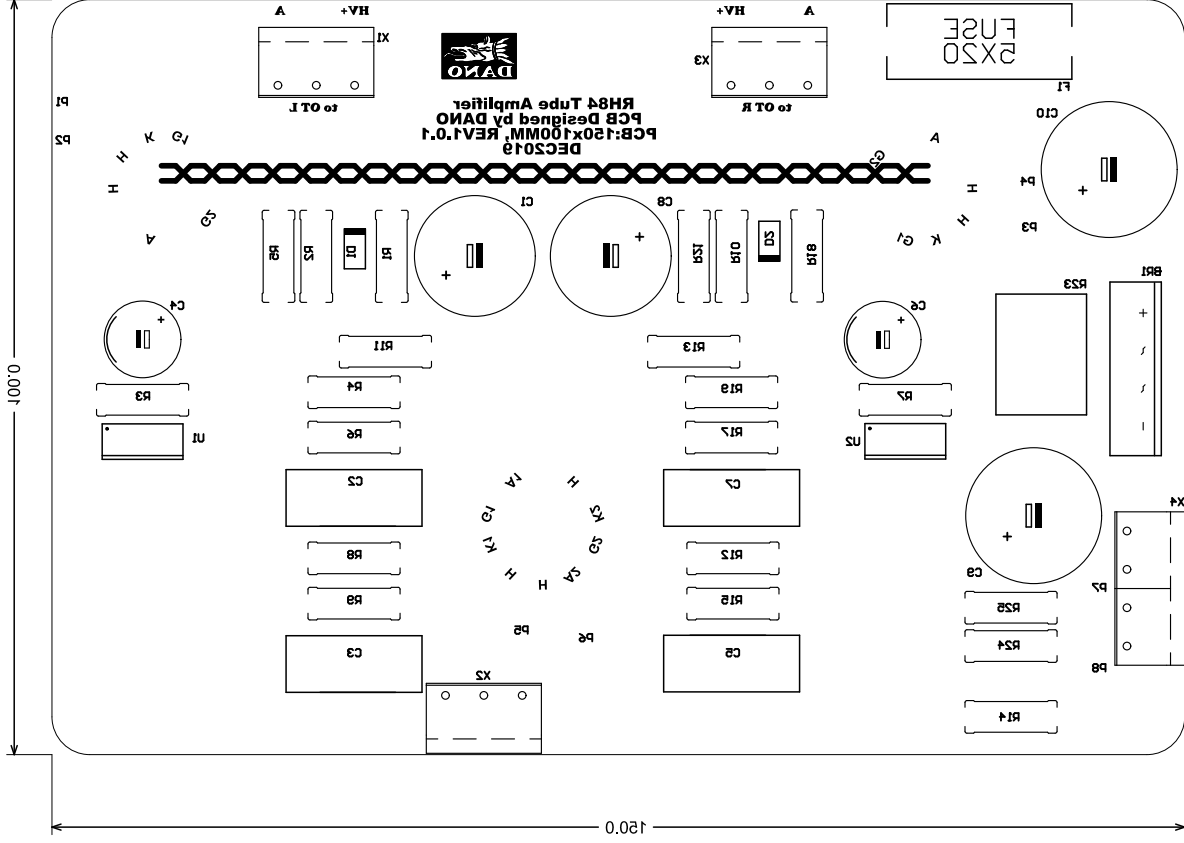

Designator	Comment	Quantity
BR1		1
C1, C8	22uF	2
C2, C3, C5, C7	220nF	4
C4, C6	100uF	2
C9, C10	220uF	2
D1, D2	21V	2
F1	100mA	1
logo	DANO	1
P1, P2, P3, P4, P5, P6, P7, P8	PIN	8
R1, R21	10k	2
R2, R4, R10, R11, R13, R19	100k/2W	6
R3, R7	27R	2
R5, R18	1k	2
R6, R8, R15, R17	470k	4
R9, R12	390R	2
R14	22R	1
R23	100R	1
R24, R25	100R	2
U1, U2	LM317	2
V1	ECC83	1
V2, V3	EL84	2
X1, X2, X3		3
X4		1